

Brass Housing Explosion Proof Warning Light

SE/ SEL/ SELR/ SE-S

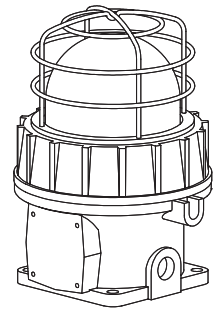
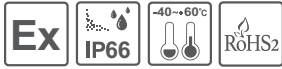

Thank you for purchasing Qlight's products. Please read this user manual carefully prior to installation and operation to ensure safe and correct use.

⚠ Safety Precautions for Explosion Proof Products

Please follow the instruction below to ensure safe and correct use of explosion proof products.

1. Explosion proof products should be managed according to explosion-proof regulations. Do not disassemble, assemble, alter or repair the product arbitrarily.
2. The temperature rating of the product is the temperature the product will experience at the applied rated voltage and ambient temperature indicated.
3. Use cable glands that satisfy the product's explosion proof grade and temperature grade.
4. Unused cable entries must be filled with material that meets the explosion proof grade and temperature rating.
5. Before installing the product, please make sure all cautions indicated on the labels, packaging, and operation manual of the product are fully understood.
6. Installation, maintenance and repair of the product must be performed by experts in the explosion proof field, or persons who have received relevant training.
7. For safety, the product should be installed and operated in environments that avoid high temperature and high pressure.
8. Please follow general safety precautions and avoid installing the product in locations that may generate excessive heat.
9. When installing the product in places where chemicals are located, please make sure that the environment does not have two or more incompatible chemicals mixed. For safety, please read the instruction manual carefully and be mindful of the chemical compositions where the product is used.
10. This product requires grounding.

⚠ Precaution for Safety

Failure to follow the instructions below may cause a loss of life or serious physical injury.

1. During wiring or maintenance, please completely turn off the power of the product. (Failure to follow this may lead to an electric shock.)
2. Do not install the product in locations that subjects it to excessive dust or water other than the conditions designated by the IP protection ratings indicated for each product. (Failure to follow these instructions may cause a fire to the product, electric shock, physical injury, malfunction or damage to the product.)
3. Do not alter or repair this product. If maintenance or repair service is required, please contact your local Qlight contact point. (Failure to follow these instructions may lead to fire, electric shock, or product damage.)
4. Please apply the correct voltage to the product. (Failure to follow these instructions may lead to fire, electric shock, or product damage.)
5. When the product is applied to a condition that may impact lives or property, please make sure to have a double safety device. (Failure to follow this may cause damage to property, fire, electric shock and loss of life.)

⚠ Precautions for Correct Use

Failure to follow the proper instructions may cause damage to property, the product, or malfunction of the product that would void the warranty.

1. Please remove any objects that can interrupt ventilation around the product.
2. Please turn off the power of the product immediately if it fails to operate properly.
3. Carefully wire the product according to each product's specification.
4. Please be careful in preventing chemicals such as thinner, benzene, etc. in contact with the surface of the product.
5. Do not apply excessive force/impact to the product.
6. Failure to follow any of the instructions above may cause malfunction or damage to the product, fire, and electric shock.

Ordering Specifications

SE	-	220	-	R
[Model number]		[Voltage]		[Color]
• SE		• 12-DC12V		R-Red
• SEL		• 24-DC24V		A-Amber
• SELR		• 110-AC110V		G-Green
• SE-S		• 220-AC220V		B-Blue



Please scan the QR code for more detailed product information.

www.qlight.com



Product Specifications



Explosion Proof Specifications

Model number	SE
	SEL
	SELR
	SE-S
Range of operating voltage	DC 12V or 24V AC 110V or 220V
Ex mark	Ex d II C T6
Ambient operating temperature	-40°C ≤ Ta ≤ 60°C
Explosion proof Zone	Zone1, Zone2
Protection rating	IP66

Zone definitions(Gas)	Zone 1	High risk gas/vapour(Gas)
	Zone 2	Medium risk gas/vapour(Gas)
Group definitions(Gas)	GROUP II A	Acetone, Petrol, Methanol, Propane, Toluene
	GROUP II B	Ethylene, City gas
	GROUP II C	Hydrogen, Acetylene, Carbon sulphide
Maximum surface temperature of electrical Equipment	T1	450°C
	T2	300°C
	T3	200°C
	T4	135°C
Zone definitions(Dust)	T5	100°C
	T6	85°C
Group definitions(Dust)	Zone 21	High risk powder/dust(Dust)
	Zone 22	Medium risk powder/dust(Dust)
Group definitions(Dust)	GROUP II A	Ignitable fibers/flyings(more than 0.5mm)
	GROUP II B	Non-conductive dusts
	GROUP II C	Conductive dusts

General Product Specifications

Model number	Voltage	Current	Bulb specifications			Certificates	Weight	Color
			Volts/Watts	Configuration	Part#			
SE	DC12V	1.545A	12V10W	G23 15S	17		R-Red A-Amber G-Green B-Blue	
	DC24V	0.766A	24V10W	G23 15S	18			
	AC110V	0.204A	12V10W	G23 15S	17			
	AC220V	0.102A	12V10W	G23 15S	17			
SE-S	DC12V-24V	Max. 0.435A	220V-350V	BGA2120 -BBC I type	47		R-Red A-Amber G-Green B-Blue	
	AC110V	0.075A						
	AC220V	0.060A						

Model number	Voltage	Current	Certificates	Weight	Color
SEL	DC12V-24V	Max.0.125A		13.29kg	R-Red A-Amber G-Green B-Blue
	AC110V	0.035A		14.26kg	
	AC220V	0.025A		13.35kg	
SELR	DC12V	0.183A		13.35kg	R-Red A-Amber G-Green B-Blue
	DC24V	0.127A		13.91kg	
	AC110V	0.035A		13.91kg	
	AC220V	0.017A			

Dimensions

(Units : mm)

SE/ SEL/ SELR/ SE-S

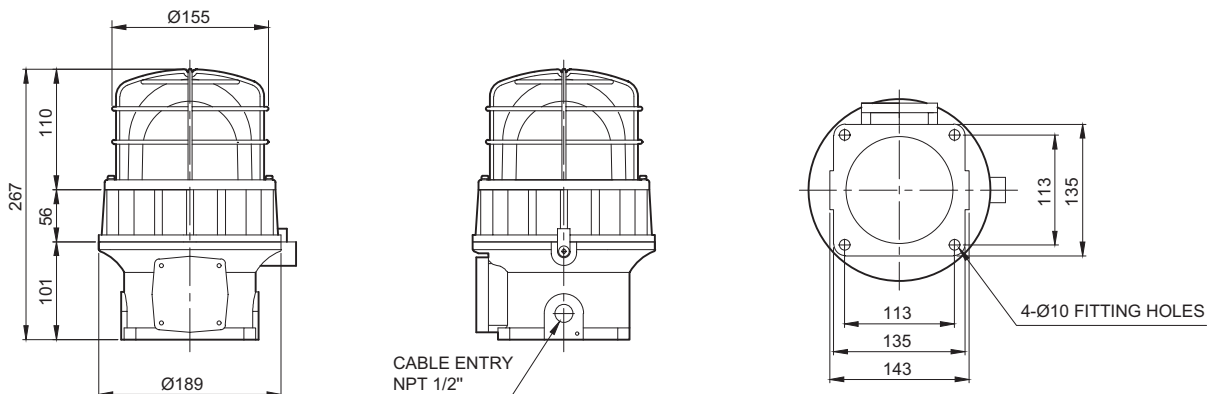

Terminal Box Wiring Instructions

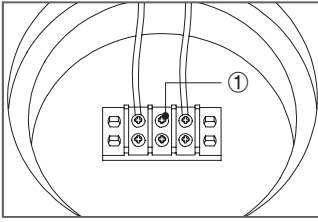

- Terminal block is located inside of the product. Unscrew the 4 bolts located in the upper body to get rid of the upper lighting element of the unit.
- Please apply fork (U-type) or ring (O-type) locking spade terminal at naked tip of the wire for secure connection.
- Please wire the power line to terminal ①
- For AC type products, wire regardless of polarity.
- For DC type products, wire terminal of black line to (-) polarity.

Parts Definition/ Installation/ Mounting Hole Specifications

■ Parts Definition/ Installation

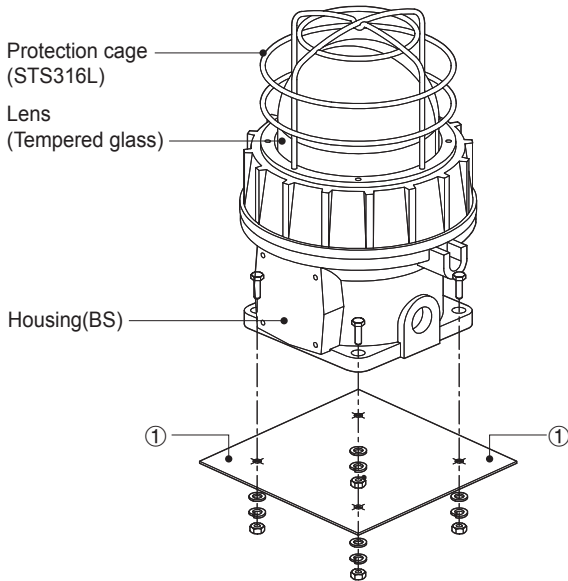

- First, machine taps or holes on the mounting surface ①.
 - The mounting hole of this product is 10mm in diameter(hole).
 - When machining taps, fasten the bolt through the mounting hole of the product.
 - When machining holes, insert the bolt through the hole of the product, and tighten the nut from the opposite side of the mounting surface.
- (When assembling using bolt and nut, please make sure to use flat washer and spring washer.)

■ Mounting Hole Specifications

- Machine holes on the mounting surface referring to the diagram below.

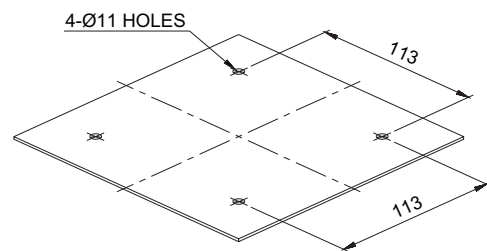

Grounding Instructions

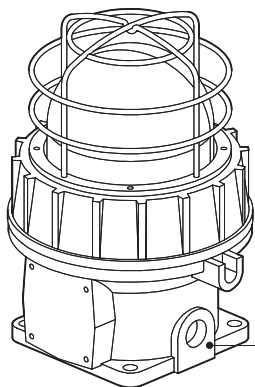

M4 ground contact part

- Please use an M4 bolt at the location marked in the diagram above to ground the product.
- When connecting the grounding cable, please use a ring terminal.
- Please use a grounding cable with a diameter greater than 4mm.

Bulb Replacement Instructions/ Xenon Bulb Replacement Instructions

■ Bulb Replacement Instructions(SJD only)

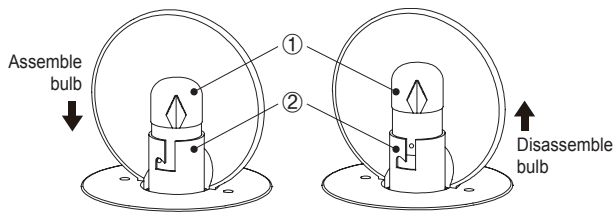

- Please wait at least 1 minute after turning off the power before replacing the bulb.
- In order to disassemble the bulb, please push down the bulb(①) lightly and screw it counterclockwise.
- In order to put the bulb in to the unit, please place the bulb(①) in the socket(②) and screw it clockwise while lightly pushing down the bulb.

■ Xenon Bulb Replacement Instructions(SJDS only)

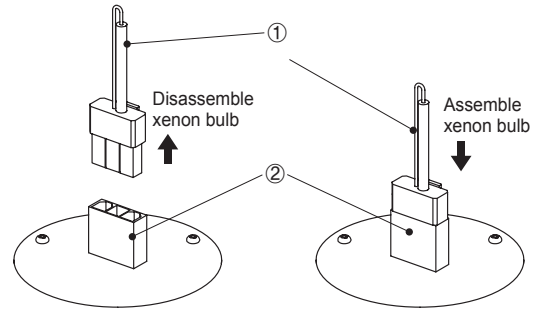

- Please wait at least 30 minutes after turning off the power before replacing the xenon bulb.
- Please pull out the entire xenon bulb structure ① to disassemble.
- For xenon bulb assembly, please ensure the connector portion of the xenon bulb structure matches the pin location②.

Installation Environment and Protection Rating

- This product is designed to be explosion proof.
- Please make sure to use the product in an environment that meets the specified explosion proof rating and regulations.
- For further information, please visit our website (www.qlight.com).

Technical Certification

- Qlight products are designed to meet strict quality and technical standards. Thus, the Qlight brand is widely recognized for its high quality and technical innovations from leading institutions around the world.



ISO International Organization for Standardization

Qlight quality assurance systems have been certified by ISO by applying the ISO 9001:2008, KS Q ISO 9001:2009 regulation.



IECEX International Explosion Proof Certification (IECEX)

Certified that Qlight's products are being manufactured and manage according to international standards.



ATEX The European Regulatory Framework or Manufacture, Installation and Use of Equipment in Explosive Atmospheres

Qlight's explosion proof products comply with ATEX Directives 94/9/EC.



NEPSI National Supervision and Inspection Center for Explosion Protection and Safety of Instrumentation

Qlight's design and manufacturing system meets the People's Republic of China National explosion proof Standard. (Chinese Standard-GB3836/GB12476)



KCs Explosion Proof Device Safety Certification System

The safety performance of machines and equipment subject to safety certification and Technical capability and production system have been certified safety certification standards.



TIIS Japan Explosion-proof Certification

TIIS is a Japanes explosion proof test and certification system accordance with the Ministry of Health, Labour and Welfare Notice and the explosion proof guidelines for factory electrical equipment. Qlight's explosion proof products hasve been tested and certified by TIIS.



ABS American Bureau of Shipping

Qlight's design and quality assurance system has been certified by the American Bureau of Shipping.



RMRS Russian Maritime Register of Shipping

Qlight's design and quality assurance system has been certified from Russian Maritime Register of Shipping.



CCS China Classification Society

Qlight's design and quality assurance system has been certified by the China Classification Society.



KR Korean Register of Shipping

Qlight's design and quality assurance system has been certified by the Korean Register of Shipping.



LR Lloyd's Register

Qlight's design and quality assurance system has been certified from Lloyd's Register.



E-mark Commission Directive Regarding Vehicle Industry

Qlight has obtained EU mark for approved vehicles and vehicle components sold into the EU(EEA : European Economic Area)



KC Korea Safety Certification

Qlight's products are certified by KC for preventing accident caused by fire.



KCC Conformity Assessment of Broadcasting Communication Equipment

Qlight has been certified to protect the electromagnetic environment that causes unwanted electromagnetic waves from the device, communication failure due to other devices or external radio waves, and malfunction of the device.



CCC China Compulsory Certificate

Qlight's has obtained CCC which guarantees safety, protection against fraud, environment, etc.



CCCF China Certification Center for Security & Protection

Qlight has passed the rigorous examination process of "Passing Fire Protection Products Centering" In order to sell fire-fighting products such as fire alarm equipment to Chinese market.



UL Underwriters Laboratories

Qlight's design and quality assurance system has been certified from UL to ensure the stability of consumption goods and to protect consumers.



CE European Commission

Qlight has been certified by the European Commission.



ICAO International Civil Aviation Organization

Qlight guarantees our products satisfy the criteria regulated by the International Civil Aviation Organization(ICAO, FAA).



RoHS2 Restriction of Hazardous Substances Directive

Qlight c omplies with the Restriction of Hazardous Substances Directive by limiting its use of hazardous materials.

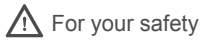

For your safety

Specification and dimensions listed in this catalogue subject to change without notice for product quality improvement.
The newest product information is available on our website.(www.qlight.com)
Please read the instruction manual attached to the product carefully before installation and use.

Qlight Co., Ltd. www.qlight.com | trade@qlight.com

Head Office | Suite #1510, STX-V Tower, 128 Gasan digital 1-ro, Geumcheon-gu, Seoul, Korea Tel. +82-80-328-2222 Fax : +82-2-2679-6154

Factory | 185-25, Mukbang-ro, Sangdong-myeon, Gimhae-si, Gyeongsangnamdo, Korea Tel. +82-80-328-1111

Qlight Overseas Sales Dept | 704 Nakdong-daero, Sasang-gu, Busan, Korea(Eomgung-Dong) Tel : +82-51-620-4100

Qlight Public Relations & Marketing Team Office | 704 Nakdong-daero, Sasang-gu, Busan, Korea(Eomgung-Dong) Tel : +82-51-245-0017

Qlight USA, Inc. www.qlight.com www.qlightusa.com | sales@qlightusa.com

3003 North First Street, Suite #341, San Jose, CA 95134 USA Tel. +1.408.519.5740 Fax. +1.408.519.5739

SHANGHAI Qlight Electronic Co., Ltd. www.qlight.com www.qlightcn.com | qlightcn@qlight.com

China Factory/ Shanghai Sales Office | #19, Nanda Road, Baoshan Area, Shanghai, China Tel. +86.21.6651.7100 Fax. +86.21.6315.3929

Qlight
Innovation in Alarm & Signal

Product Operation Inquiry / Customer Support +82-51-620-4100

You can expect prompt service if you have exact information such as model name, symptom, telephone number and address.

※ALL PRODUCT, PRODUCT SPECIFICATIONS AND DATA ARE SUBJECT TO CHANGE WITHOUT NOTICE TO IMPROVE RELIABILITY, FUNCTION OR DESIGN OR OTHERWISE.

Head office : Suite #1510, STX-V Tower, 128 Gasan digital 1-ro, Geumcheon-gu, Seoul, Korea (Postal Code : 08507)

Factory : 185-25, Mukbang-Ro, Sangdong-Myeon, Gimhae-Si, Gyeongsangnam-Do, Korea (Postal Code : 50805)

www.qlight.com

EN - SE -1911A